

Installation Instructions Aalto Plus and Bro Plus

● This installation guide applies to Aalto Plus and Bro Plus panels. By following these instructions, you will achieve the best possible result.

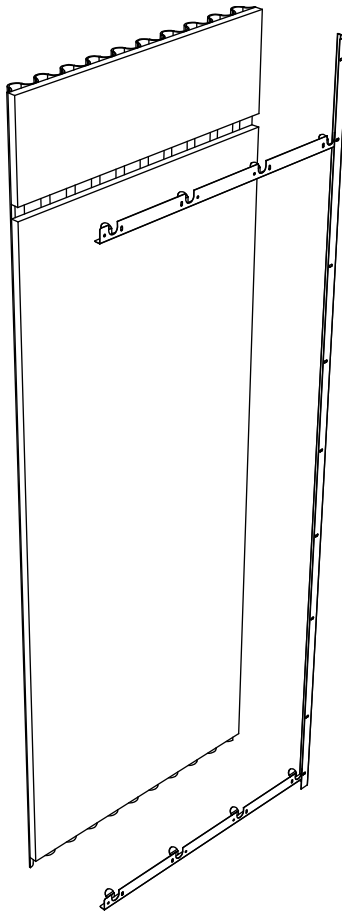

1

1. Plus edge trims
2. Plus brackets (900 mm)
3. Wall plugs and mounting screws
4. Drill driver
5. Spirit level
6. Pencil

Materials

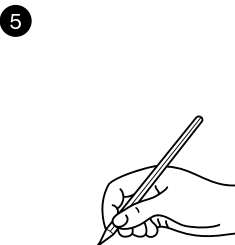
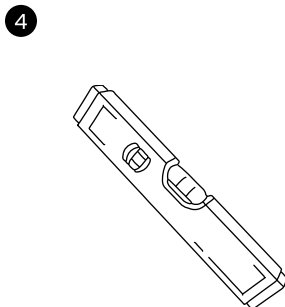
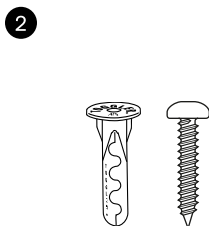
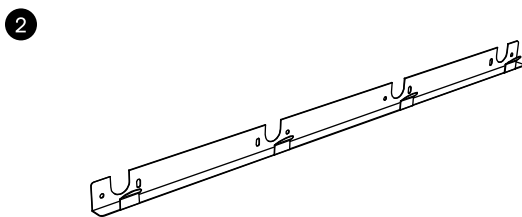
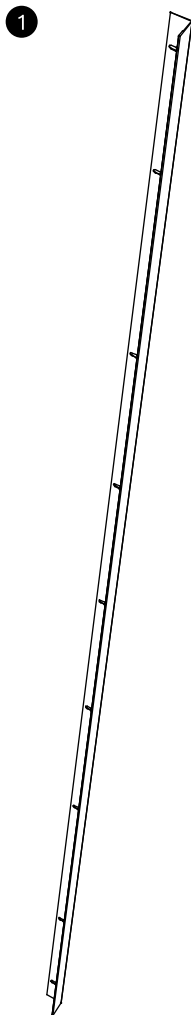

2

General

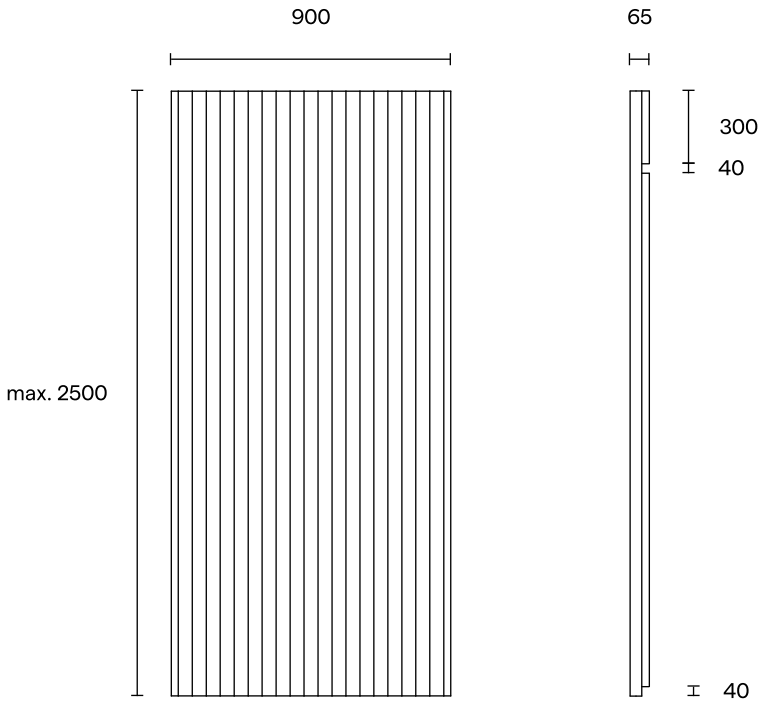

The distance from the top edge of the panel to the bottom edge of the upper bracket is 300 mm. The distance from the bottom edge of the panel to the lower bracket is 40 mm.

Ensure that the wall structure is suitable for mounting the panels and always use fixings appropriate for the installation surface.

Panels can be installed both side by side and stacked vertically.

3

Installation

1. Mark the positions of the brackets according to the planned panel layout.
2. Two brackets are required per panel. You can start the installation from either the right or the left side.
3. Draw the layout lines on the mounting surface using a spirit level.

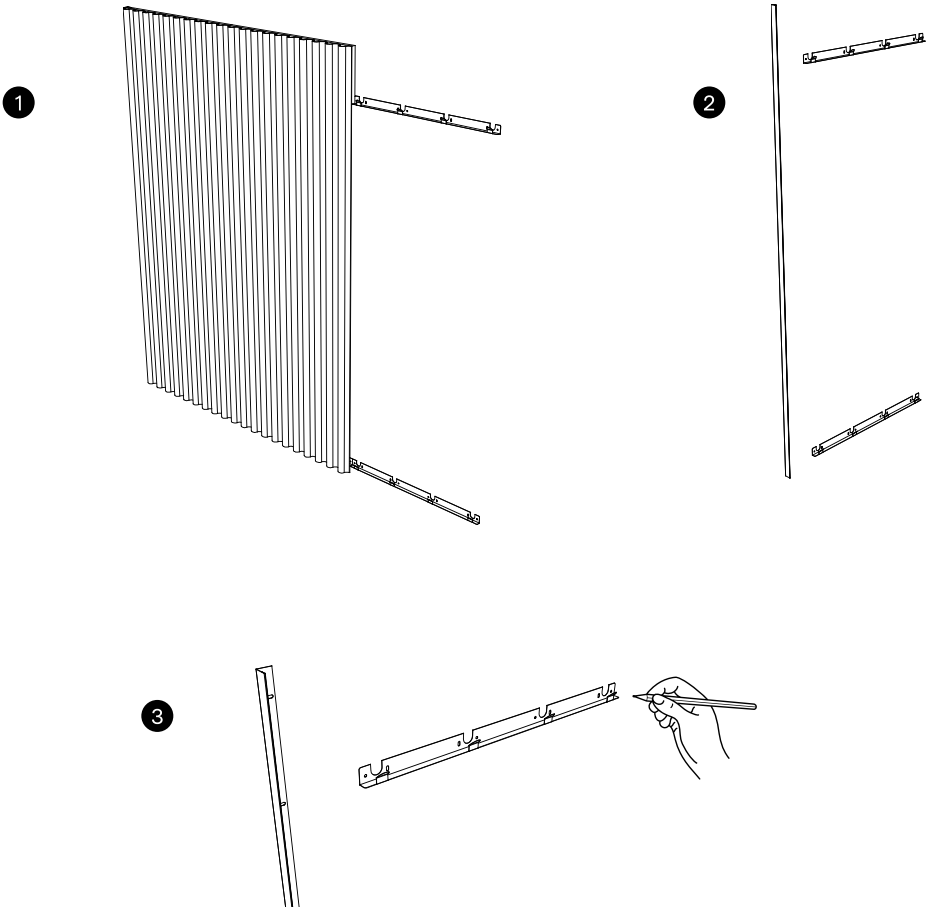

4. Fix the brackets for the panel assembly with screws. The edge trim is installed under the same screw together with the bracket.

5. Leave the final edge trim uninstalled for now.

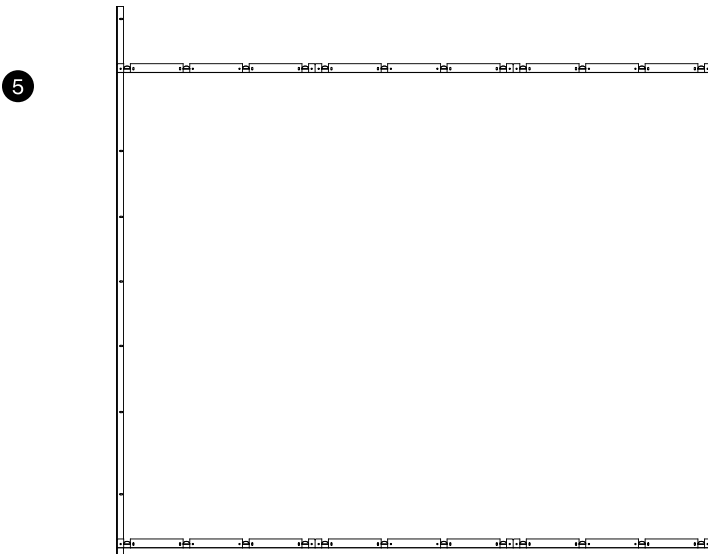
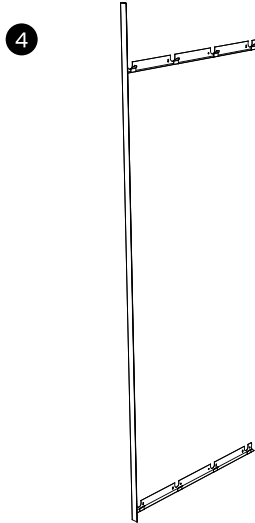

6. Hang the panels onto the brackets. Make sure the panels are tightly against each other, with the joints aligned.

7. Mark the edge of the last panel and remove the final panel.

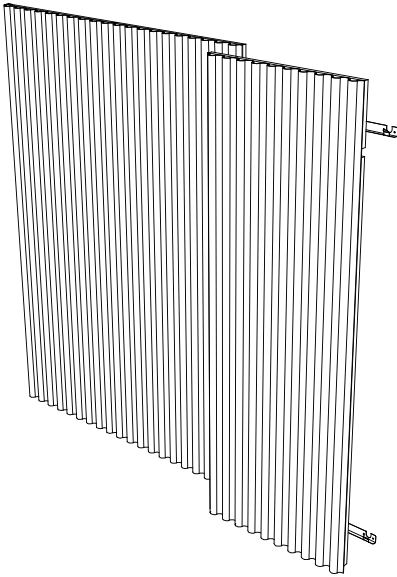

6

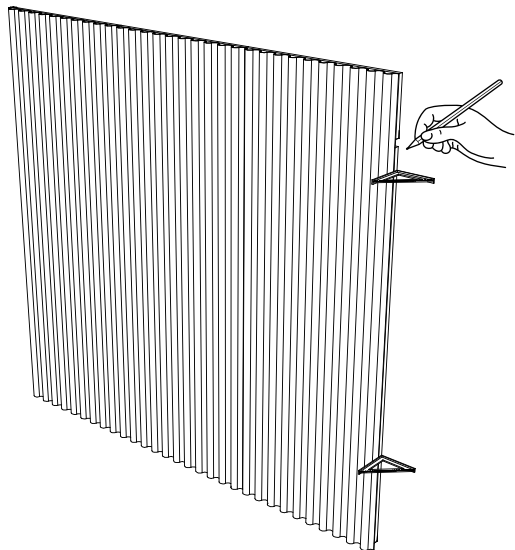

7

8. Remove the brackets from the last panel and install the edge trim at the marked position, under the brackets.

8

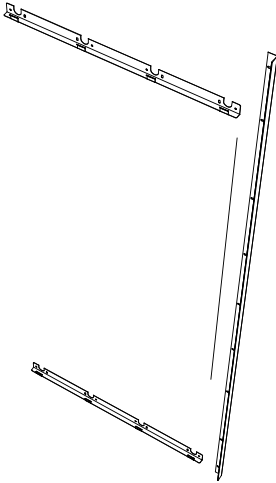

9. Install the final panel against the edge trim and once again check the panel joints.

9

